

Motion detector

IS 360-1 DE

black
EAN 4007841 032852
Article number 032852



infrared sensor
360°



max. 4 m

1000 W

1000 W max. (LED-ready)



IP54



2 - 2000 lux



8 sec - 35 min



ideal 2.2 m



energy saving

3 years

manufacturer's
warranty
steinel.de/
garantie3y



CE

Function description

Intelligent technology for installation. Infrared wall sensor IS 360-1 DE, for indoors and out, ideal for installing in projecting roofs and suspended ceilings, 360° angle of coverage, reach can be set up to 4 m, selectable time and twilight threshold, detection zone can be customised with shrouds.

Technical specifications

Dimensions (Ø x H)	78 x 89 mm	LED lamps < 2 W	16 W
Manufacturer's Warranty	3 years	LED lamps > 2 W < 8 W	64 W
Settings via	Potentiometers	LED lamps > 8 W	64 W
With remote control	No	Capacitive load in µF	132 µF
Version	black	Sensor Technology	Passive infrared
PU1, EAN	4007841032852	Mounting height	2,50 – 4,00 m
Type	Motion detectors	Mounting height max.	4,00 m
Application, place	Outdoors, Indoors	Optimum mounting height	2,5 m
Application, room	outdoors, front door, all round the building, terrace / balcony, Indoors	Detection angle	360 °
Colour	black	Angle of aperture	90 °
Colour, RAL	9005	Sneak-by guard	Yes
Includes corner wall mount	No	Capability of masking out individual segments	Yes
Installation site	ceiling	Electronic scalability	No
Installation	In-ceiling installation, Ceiling	Mechanical scalability	No
IP-rating	IP54	Reach, radial	Ø 4 m (13 m ²)
Protection class	II	Reach, tangential	Ø 8 m (50 m ²)
Ambient temperature	-20 – 40 °C	Switching zones	304 switching zones

<https://www.steinell.de>

Subject to technical modifications

03.2023 Page 1 from 3

Motion detector

IS 360-1 DE

black
EAN 4007841 032852
Article number 032852



Technical specifications

Material	Plastic
Mains power supply	230 – 240 V / 50 – 60 Hz
Switching output 1, resistive	1000 W
Switching output 1, number of LEDs / fluorescent lamps	6 pcs.
Fluorescent lamps, electronic ballast	430 W
Fluorescent lamps, uncorrected	500 VA
Fluorescent lamps, series-corrected	406 VA
Fluorescent lamps, parallel-corrected	406 VA
Switching output 1, low-voltage halogen lamps	1000 VA

Twilight setting	2 – 2000 lx
Time setting	8 s – 35 Min.
Basic light level function	No
Main light adjustable	No
Twilight setting TEACH	No
Constant-lighting control	No
Interconnection	Yes
Type of interconnection	Master/master
Interconnection via	Cable

Motion detector

IS 360-1 DE

black
EAN 4007841 032852
Article number 032852



Detection Zone

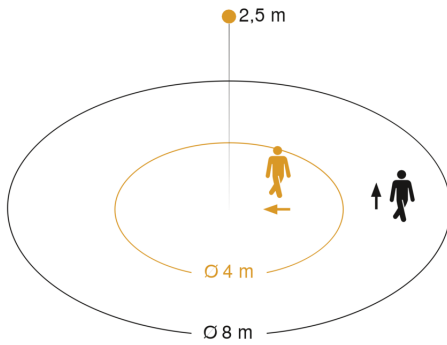

Mögliche Montagehöhe: 2,50 m – 4,00 m
Orange: radial
Schwarz: tangential

Dimension Drawing

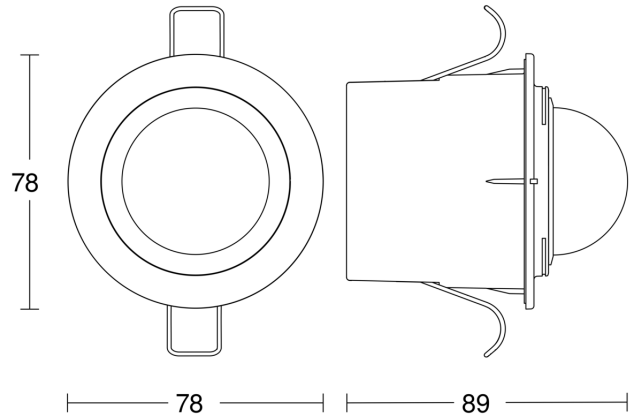

Light without neutral conductor

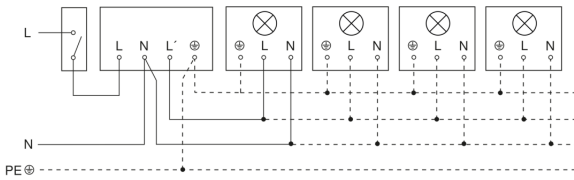

Light with neutral conductor

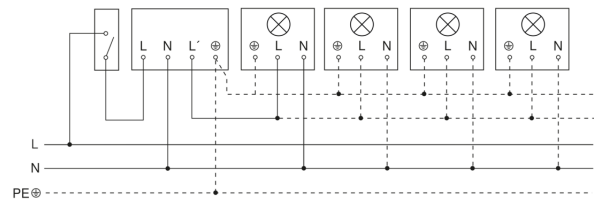

Connection using two-circuit switch for manual and automatic operation

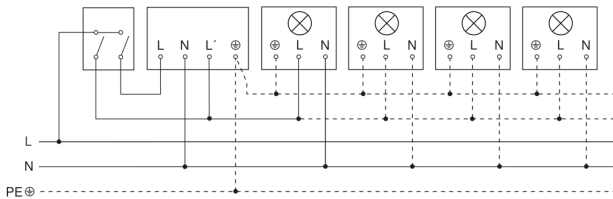

Circuit diagram Connection via a changeover switch for continuous and automatic operation

