

Motion detector

IS 360-3

black
EAN 4007841 006525
Article number 006525



infrared sensor
360°



max. 12 m

2000 W

2000 W max. (LED-ready)



IP54



2 - 1000 lux



5 sec - 15 min



Ideal 2 m



energy saving

3 years

manufacturer's
warranty
steinel.de/
garantie3y



CE

Function description

The multi-talent for indoors and outdoors. Infrared wall sensor IS 360-3, ideal for mounting under soffits, in carports, on large building facades and driveways, 3 pyro sensors for a 360° angle of coverage, reach can be set up to 12 m, selectable time and twilight threshold, detection zone can be customised with shrouds.

Technical specifications

Dimensions (Ø x H)	121 x 57 mm	LED lamps < 2 W	100 W
Manufacturer's Warranty	3 years	LED lamps > 2 W < 8 W	300 W
Settings via	Potentiometers	LED lamps > 8 W	600 W
With remote control	No	Capacitive load in µF	176 µF
Version	black	Sensor Technology	Passive infrared
PU1, EAN	4007841006525	Mounting height	2,50 – 6,00 m
Type	Motion detectors	Mounting height max.	6,00 m
Application, place	Outdoors, Indoors	Optimum mounting height	2,8 m
Application, room	outdoors, all round the building, Indoors	Detection angle	360 °
Colour	black	Angle of aperture	90 °
Colour, RAL	9005	Sneak-by guard	Yes
Includes corner wall mount	No	Capability of masking out individual segments	Yes
Installation site	ceiling	Electronic scalability	No
Installation	Surface wiring, Ceiling	Mechanical scalability	No
IP-rating	IP54	Reach, radial	Ø 6 m (28 m ²)
Protection class	II	Reach, tangential	Ø 24 m (452 m ²)

<https://www.steinel.de>

Subject to technical modifications

03.2023 Page 1 from 3

Motion detector

IS 360-3

black
EAN 4007841 006525
Article number 006525



Technical specifications

Ambient temperature	-20 – 50 °C
Material	Plastic
Mains power supply	220 – 240 V / 50 – 60 Hz
Switching output 1, resistive	2000 W
Switching output 1, number of LEDs / fluorescent lamps	8 pcs.
Fluorescent lamps, electronic ballast	1500 W
Fluorescent lamps, uncorrected	500 VA
Fluorescent lamps, series-corrected	900 VA
Fluorescent lamps, parallel-corrected	400 VA
Switching output 1, low-voltage halogen lamps	2000 VA

Switching zones	972 switching zones
Twilight setting	2 – 1000 lx
Time setting	5 s – 15 Min.
Basic light level function	No
Main light adjustable	No
Twilight setting TEACH	No
Constant-lighting control	No
Interconnection	Yes
Type of interconnection	Master/master
Interconnection via	Cable

Motion detector

IS 360-3

black
EAN 4007841 006525
Article number 006525



Dimension Drawing

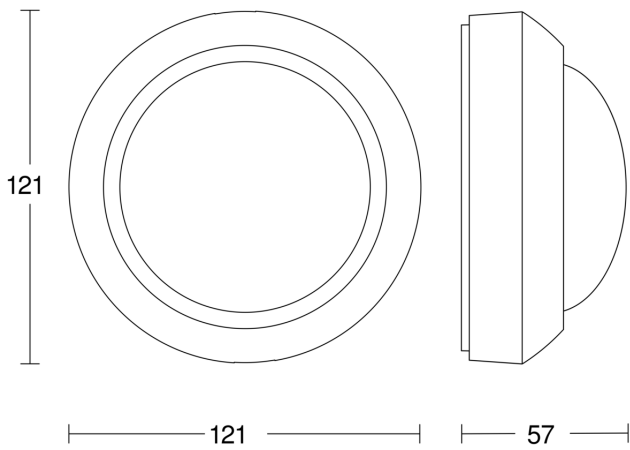

Light without neutral conductor

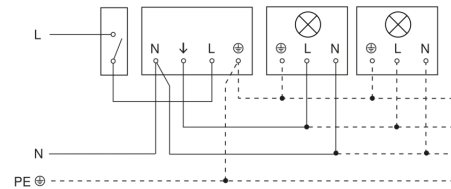

Light with neutral conductor

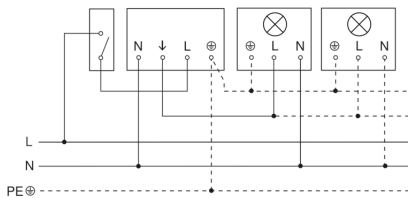

Connection using two-circuit switch for manual and automatic operation

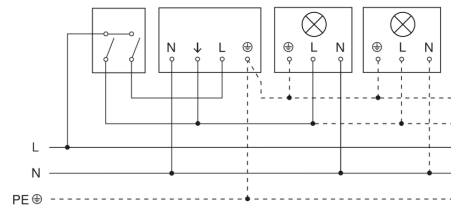

Circuit diagram Connection via a changeover switch for continuous and automatic operation

